

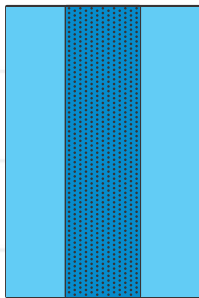

بوابة الخليج المبتكرة
Gulf Innovation Gate





Back table cover
(reinforced)

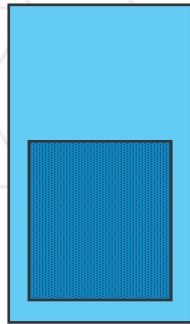

Mayo stand cover
(Reinforce)

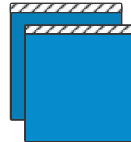

Adhesive side drape
(reinforced)

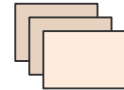

Hand towel

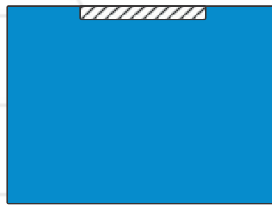

Adhesive top drape
(Reinforce)



Adhesive bottom drape
(Reinforce)



Adhesive tape strip

UNIVERSAL PACK	Size (cm)	Quantities
Mayo stand cover (reinforced)	80*145	1
Adhesive top drape (reinforced)	150*240	1
Adhesive bottom drape (reinforced)	170*190	1
Adhesive side drape (reinforced)	90*100	2
Adhesive tape strip	10*50	2
Back table cover (reinforced)	150*190	1
Hand towel	40*40	3

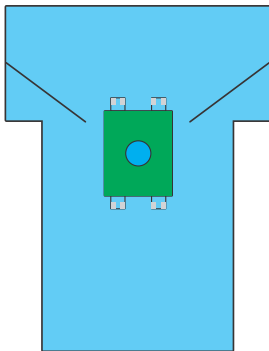

Caesarean perforated drape with pouch

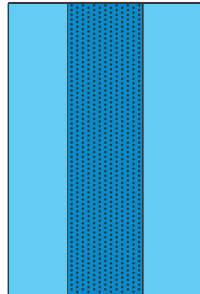

Back table cover

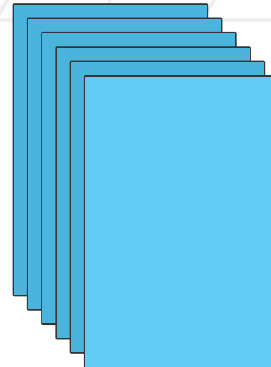

Baby table cover

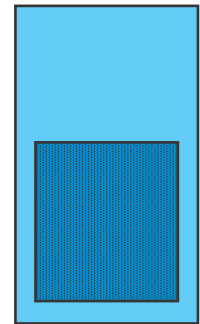

Mayo stand cover (reinforced)

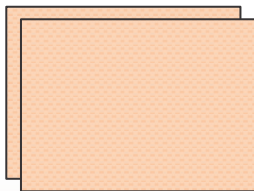

Baby blanket

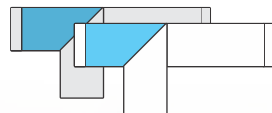

OP Tape



Umbilical cord clip



Hand towel



Poar

C.SECTION SET	Size (cm)	Quantities
Back table cover	140*190	1
Mayo stand cover (reinforced)	80*145	1
Caesarean perforated drape with pouch	200*250*310	1
Absorbent towel	30*40	1
Baby table cover		6
Baby blanket	60*90	2
OP Tape		2
Umbilical cord clip		1
Poar		1

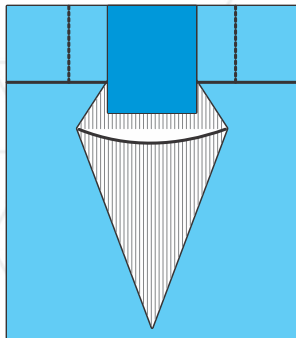

UNDER BUTTOCKS DRAPE WITH
FLUID COLLECTION POUCH

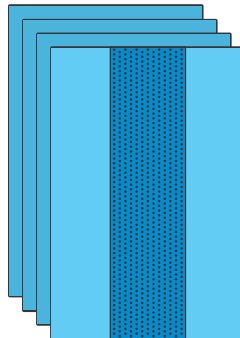

Back table cover

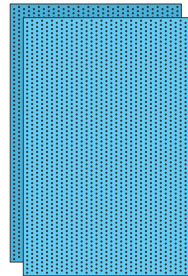

Baby drape

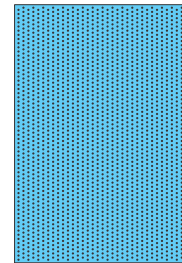

Utility drape

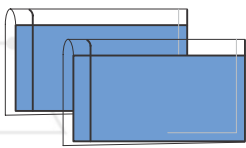

Legging



Gauze swab



Forceps



Hand towel



Umbilical cord clip

DELIVERY PACK	Size (cm)	Quantities
Utility drape	75*120	1
Under buttocks drape	60*90	1
Baby drape	75*120	2
Back table cover	140*190	4
Absorbent towel	30*35	1
Gauze swab		4
Legging	75*120	1
Umbilical cord clip		1
Forceps		1

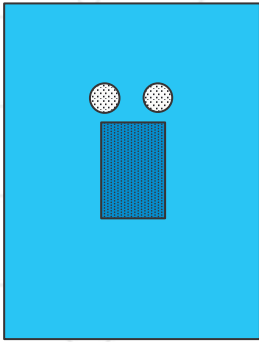

Angiography drape

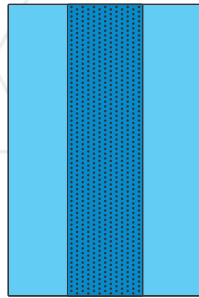

Back table cover
(reinforced)

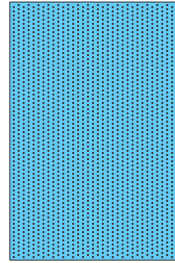

Drape

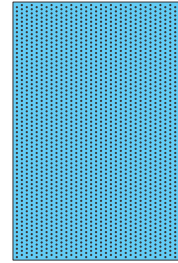

Drape iso-seal
positioning tape



Cover elastic

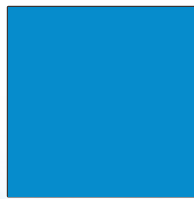

CSR Wrap

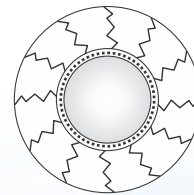

Lead cover with elastic

ANGIOGRAPHY DRAPE PACK (Accessories)	Size (cm)	Quantities
CSR Wrap		1
back table cover (reinforced)	150*190	1
Cover elastic		1
Lead cover with elastic	13*36	1
Drape ISO-Seal positioning tape	127*135	1
drape	127*135	1
Angiography drape with two 6.35 cm circular fenestration iso seal positioning tape, control plus fabric reinforcement		1

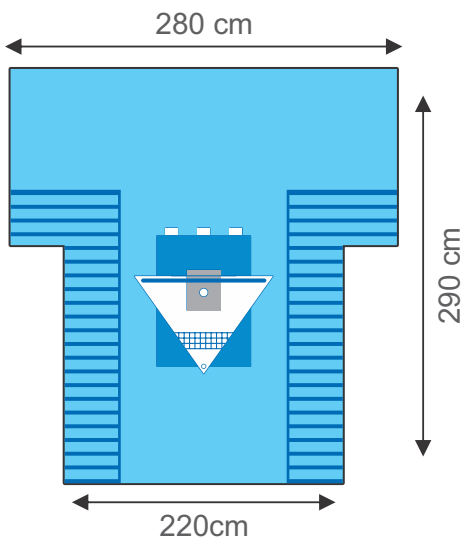

Arthroscopy T drape with fluid collection pouch

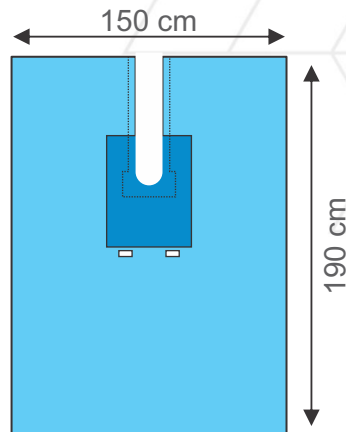

U Split shaped drape with adhesive and absorbent

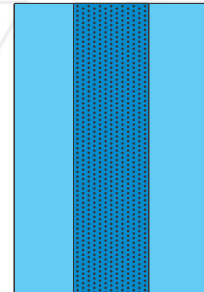

Back table cover (reinforced)

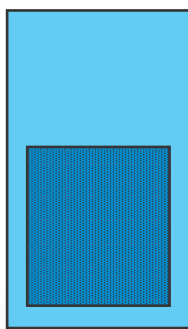

Mayo stand cover (Reinforce)

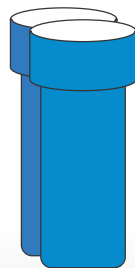

Impervious stockinette



Hand towel



OP Tape

KNEE ARTHROSCOPY PACK	Size (cm)	Quantities
Arthroscopy T drape with fluid collection pouch	220*280*290	1
U Split shaped drape with adhesive and absorbent	150*190	1
Impervious stockinette		1
Back table cover (reinforce)	150*190	1
Mayo stand cover	80*145	1
OP Tape	10*50	2
Hand towel	30*40	4



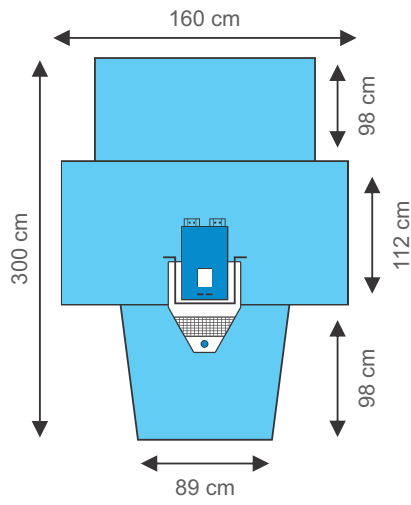

T.U.R drape with pock

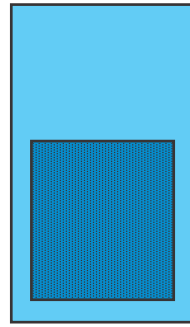

Mayo stand cover
(Reinforce)

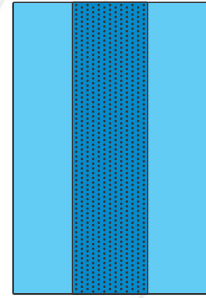

Back table cover

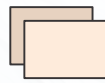

Hand towel



Adhesive tape

UROLOGY PACK	Size (cm)	Quantities
T.U.R drape with pouch	160*300*112*98*89	1
Hand towel	30*40	2
Back table cover	140*190	1
Mayo stand cover	80*145	1
Adhesive tape	10*50	2

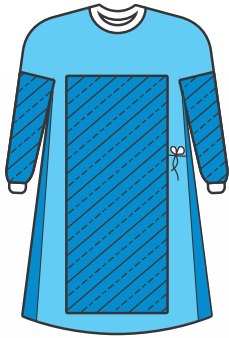

Respiratory Surgical gown

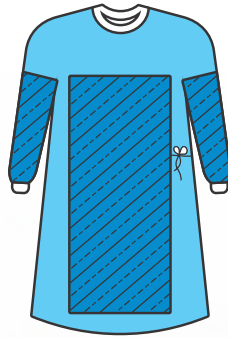

Reinforced Surgical gown

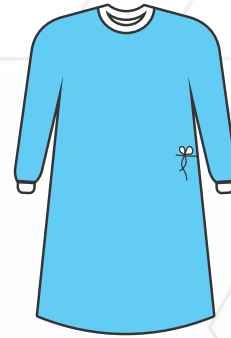

Sterile Surgical gown

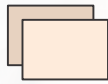

Absorbent towel

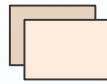

Absorbent towel

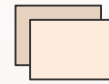

Absorbent towel

SERGICAL GOWN

Sterile Surgical Gown (With 2 Absorbent Towel)

Sterile Reinforced Surgical Gown (With 2 Absorbent Towel)

Sterile Surgical Gown Front And Sleeve Respiratory(With 2 Hand Towel)

Non-sterile Surgical Gown (38 Gsm)

Non-sterile Surgical Gown Laminate (25 Gsm)

Non-sterile Surgical Gown Front And Sleeve Laminate (38 Gsm)

Non-sterile Surgical Gown (38 Gsm)

Patient Set with Hat

Patient Set (Blue-Pink)

Mri Gown

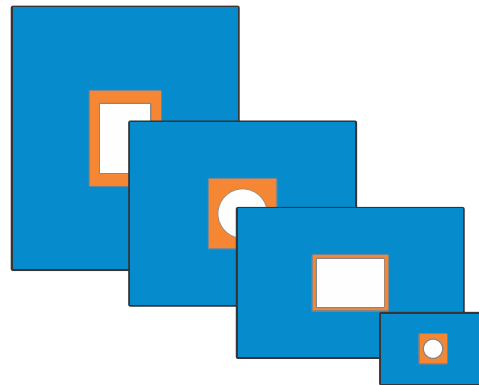
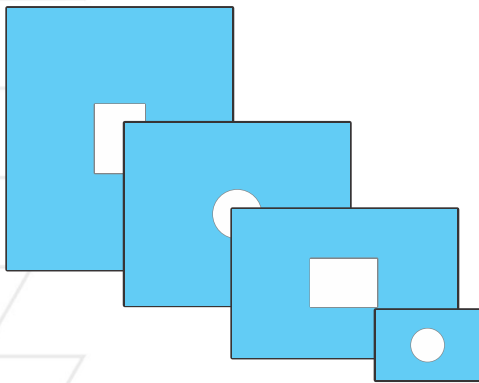
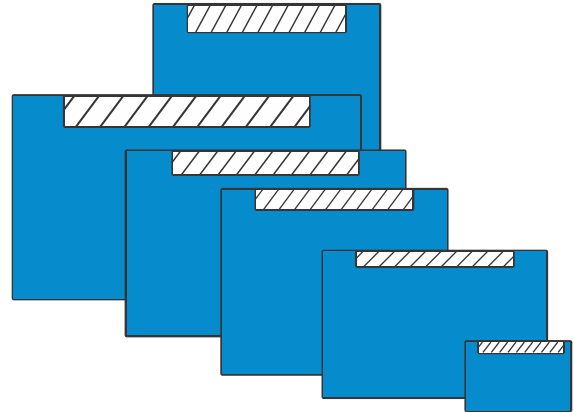
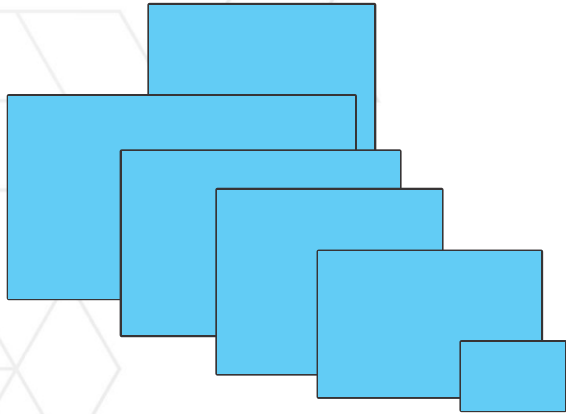

Dimension	50*50	100*80	100*100	100*120	100*150	100*200	150*150	120*200	150*250
Item Code	DT055	DT801	DT100	DT121	DT151	DT210	DT156	DT162	DT256
SMS	<h1>All available</h1>								
SB									
Laminate									
Hydrophilic									
Fenestrated									
Adhesive									

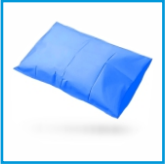

Pillow cover (White & Blue) (50 gr)

Pillow cover (White & Blue (25 gr)



sheet with loops (with bottom layer) (45gr)

80*220

sheet with loops (45gr)

80*220

sheet with loops (with bottom layer) (45gr)

120*220

sheet with loops (45gr)

120*220



disposable Surgical Cap

disposable Patient Hat

disposable accordion hat (white-blue)

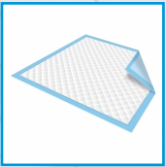

UNDER PAD (HONEST)

90*60

UNDER PAD (TINO)

90*60

UNDER PAD (BENLA)

90*60



بوابة الخليج المبتكرة
Gulf Innovation Gate



C.R No: 1437005

Contacts:

Address: Muscat, Sultanate of OMAN

Postal Code: 315 - P.O Box: 314

T e l : + 9 6 8 7 7 0 8 6 6 6 0

E-mail:Info@gulfinnovationgate.com

www.GULFINNOVATIONGATE.com